

Part Number: PT912-03180

Kit Contents

Item #	Quantity Req.	Description
1	1	Cargo Net
2		
3		

Hardware Bag Contents

Item #	Quantity Req.	Description
1		
2		
3		

Additional Items Required For Installation

Item #	Quantity Req.	Description
1		
2		
3		

Conflicts

None

Recommended Tools

Personal & Vehicle Protection	Notes
Blankets	
Special Tools	Notes
None	
Installation Tools	Notes
None	
Special Chemicals	Notes
None	

General Applicability

All 2018 & newer Camry models

Recommended Sequence of Application







Item #	Accessory
1	
2	
3	

*Mandatory

Vehicle Service Parts (may be required for reassembly)

Item #	Quantity Req.	Description
1		
2		
3		

Legend

	STOP: Damage to the vehicle may occur. Do not proceed until process has been complied with.
	OPERATOR SAFETY: Use caution to avoid risk of injury.
	CAUTION: A process that must be carefully observed in order to reduce the risk of damage to the accessory/vehicle and to ensure a quality installation.
	TOOLS & EQUIPMENT: Used in Figures calls out the specific tools and equipment recommended for this process.
	REVISION MARK: This mark highlights a change in installation with respect to previous issue.
	SAFETY TORQUE: This mark indicates that torque is related to safety.

Care must be taken when installing this accessory to ensure damage does not occur to the vehicle. The installation of this accessory should follow approved guidelines to ensure a quality installation.

These guidelines can be found in the "Accessory Installation Practices" document.

This document covers such items as:-

- Vehicle Protection (use of covers and blankets, cleaning chemicals, etc.).
- Safety (eye protection, rechecking torque procedure, etc.).
- Vehicle Disassembly/Reassembly (panel removal, part storage, etc.).
- Electrical Component Disassembly/Reassembly (battery disconnection, connector removal, etc.).

Please see your Toyota dealer for a copy of this document.

1. First Main Step.

- (a) Open the trunk and locate the anchor locations on the passenger side of the vehicle (Fig. 1-1).

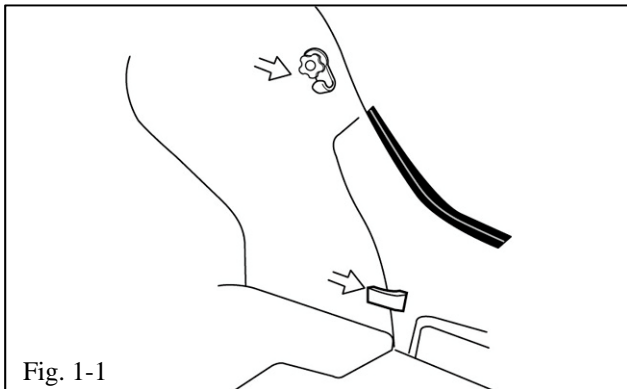

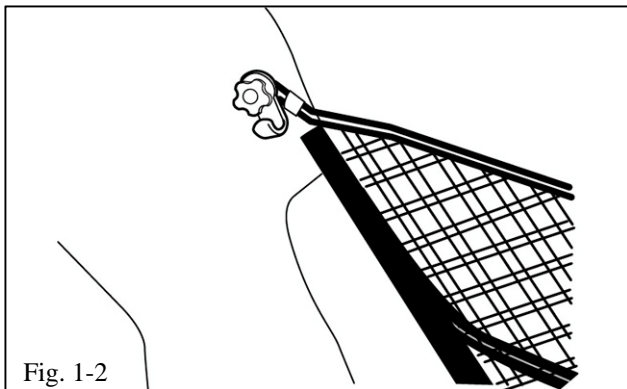

-  (b) With the net handle facing out toward the rear of the vehicle, attach the loop at the top of the net to the vehicle anchor (Fig. 1-2).

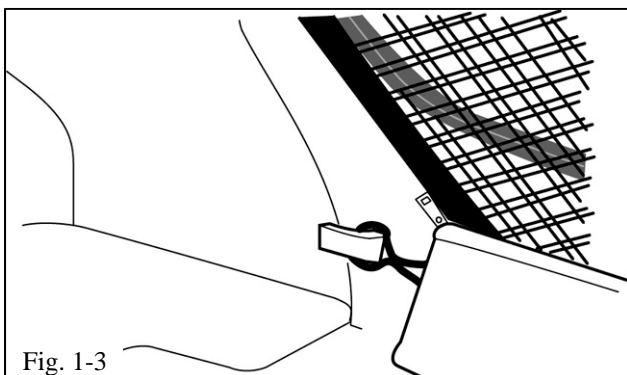

- (c) Attach the loop at the bottom of the net to the vehicle (Fig. 1-3).
- (d) Repeat Steps 1(a) through 1(c) on the driver side.

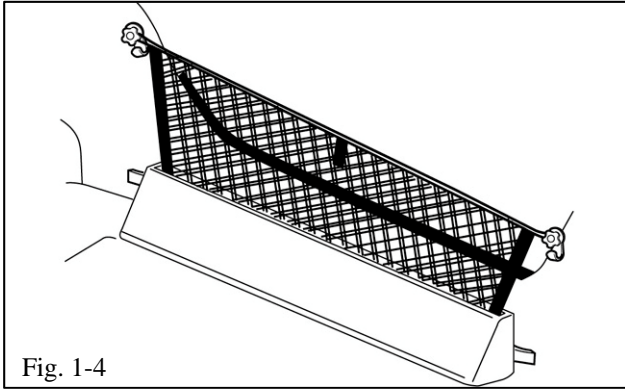



-  (e) Confirm the installation. Make sure that the net handle is facing out toward the rear of the vehicle (Fig. 1-4).

2. Note the Closing Feature.

- (a) The cargo net handle includes a feature to keep the cargo net closed when in use (Fig. 2-1).

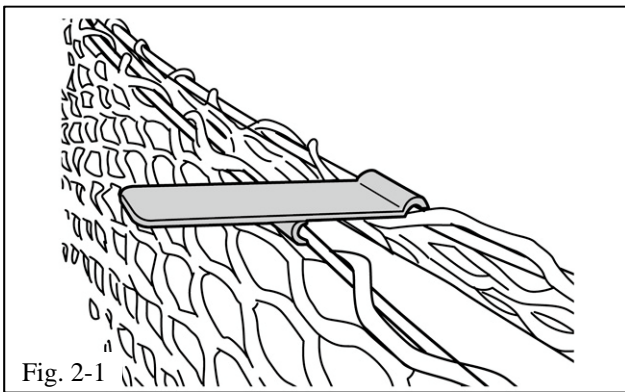

Checklist - these points **MUST** be checked to ensure a quality installation.

<u>Check:</u>	<u>Look For:</u>
<p><u>Accessory Function Checks</u></p> <p><input type="checkbox"/> Confirm that the net is attached properly to the anchor points in the vehicle</p> <p><input type="checkbox"/></p> <p><input type="checkbox"/></p>	<p>Make sure the loops are attached to the vehicle anchors at the top and bottom. The net handle should face out toward the rear of the vehicle.</p>
<p><u>Vehicle Function Checks</u></p> <p><input type="checkbox"/> Vehicle trunk operation</p> <p><input type="checkbox"/></p> <p><input type="checkbox"/></p>	<p>Confirm vehicle trunk opens and closes without interference from cargo net</p>
<p><u>Vehicle Appearance Check</u></p> <p><input type="checkbox"/> After accessory installation and removal of protective cover(s), perform a visual inspection.</p>	<p>Ensure no damage (including scuffs and scratches) was caused during the installation process. (For PPO installations, refer to TMS Accessory Quality Shipping Standard.)</p>